

BOTTOM ROLLING REVEAL FIX

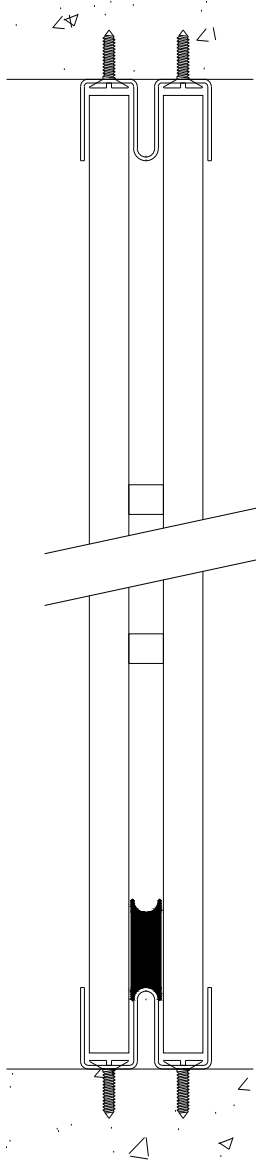

TOP HUNG FACE FIX

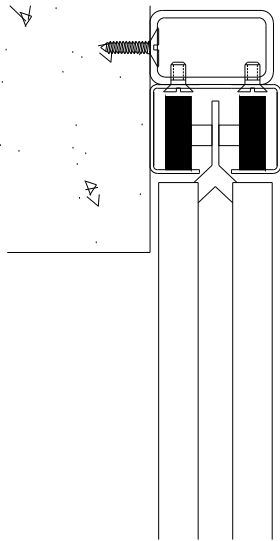

BOTTOM ROLLING FACE FIX

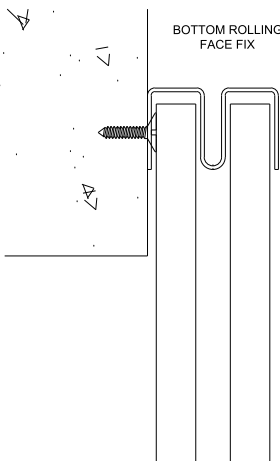

BOTTOM RUN "T" TRACK

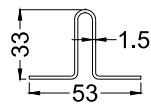

TOP HUNG "T" TRACK

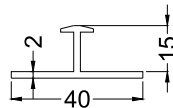

BOTTOM RUN "W" TRACK

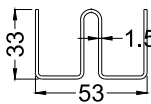

"S" LATTICE

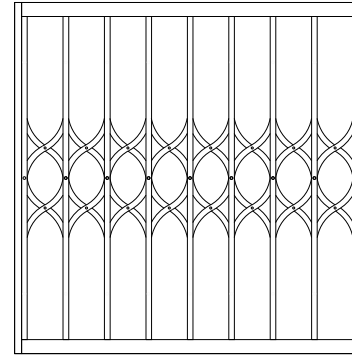

"X" LATTICE

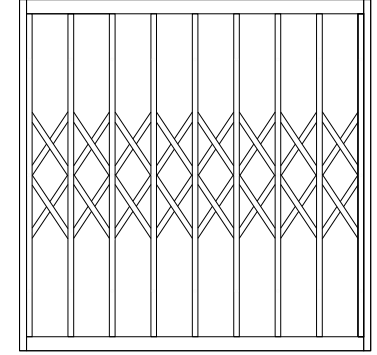

SINGLE SASH

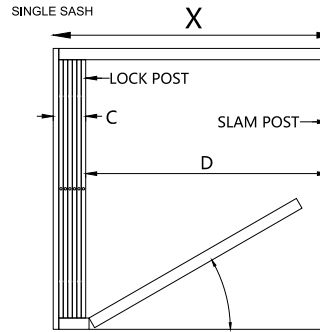

DOUBLE SASH

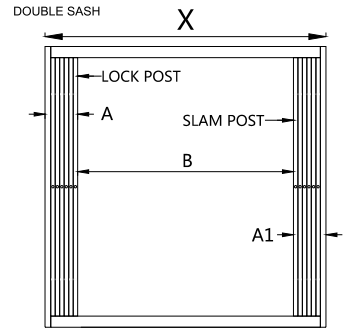

OPTIONAL HINGED/ SWIVEL OR REMOVABLE TRACK

4 ROWS

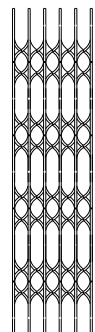

2900 >
3500

3 ROWS

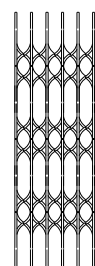

2500 >
2900

2 ROWS

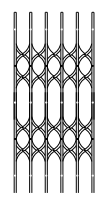

1200 >
2500

1 ROW

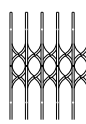

>1200

- INSURANCE APPROVED
- SBD OPTIONS AVAILABLE
- 30% HEAVIER DUTY
- TOP HUNG OR BOTTOM ROLLING (STATE WHICH IS REQUIRED ON ENQUIRY)
- STANDARD POWDER COATING 9010
- OTHER COLOURS AVAILABLE

BUNCHING DETAILS

OVERALL WIDTH (mm) X	DOUBLE SASH			SINGLE SASH	
	BUNCH SIZE - GUARD A	BUNCH SIZE -NON GUARD A1	CLEAR OPENING WIDTH (mm) B	BUNCH SIDE (mm) C	CLEAR OPENING WIDTH (mm) D
1016	125	102	789	170	806
2032	193	170	1669	306	1686
3048	261	238	2549	442	2566
4064	329	306	3429	578	3446
5080	397	374	4309	-	-
6096	465	442	5189	-	-

PRODUCT: LBS LATTICE GATES

DATE: 12.12.2019

DRAWN BY: JS

LBS GROUP GENERIC DRAWINGS

REVISION No: 1 A
DRAWING No: LBS004

Approved:

LBS GROUP
UNIT 6 STERLING
INDUSTRIAL ESTATE
RAINHAM ROAD
SOUTH
DAGENHAM
ESSEX
RM10 8TX

